

Collection of specification grade architectural downlights for commercial and institutional application. The professional optics deliver uniform light cones with low luminance and sharp cut off. The LASER BLADE LARGE downlights are available in 3 sizes, with trim or trimless design and medium, flood or wide flood distribution.

**Luminaire characteristics:**

**Power input:** 10W to 33.5W (System wattage)  
**Lumens:** 740lm to 2700lm (for 3000K, 90CRI)  
**Luminaire efficacy:** Up to 85lm/W

<b>Source:</b>	White LED (LM-80) 2700K : 90CRI, 3000K : 80CRI, 90CRI, 3500K : 90CRI 4000K : 80CRI.
<b>Lumen maintenance:</b>	80% of initial lumens at 50 000 hours (L80) (LM79).
<b>Optics:</b>	Low luminance medium, flood, wide flood.
<b>Material:</b>	Body and heat sink: Die-cast aluminum, Reflector and baffle: Metalized thermoplastic, Connection box: galvanized steel.
<b>Mounting:</b>	New construction with plaster frame, See page 3 for details.
<b>Electrical:</b>	Integral high efficiency power supply rated at 50 000 hours, 120V or 277V.
<b>Dimming:</b>	Supplied standard with leading (triac) and trailing edge (ELV) or 0-10V down to 15%.
<b>Finish:</b>	See page 2 for details.
<b>Weight:</b>	1.1 to 3.31lbs (0.5 to 1.5kg)
<b>Warranty:</b>	5 year limited warranty.
<b>Ratings:</b>	IP20, IP44 (from under the ceiling).
<b>Certification:</b>	 cULus listed for damp location

**ORDERING INFO**

**ILB** - - - - -  
FIXTURE MOUNTING

**MODEL**

**L1** - Single       **L2** - Double       **L3** - Triple

**MOUNTING**

**TR** - Trim       **TL** - Trimless

**LED**

**927** - 2700K, 90 CRI       **930** - 3000K, 90 CRI       **935** - 3500K, 90 CRI       **830** - 3000K, 80 CRI<sup>(1)</sup>       **840** - 4000K, 80 CRI

**OPTIC**

**M** - Medium<sup>(2)</sup>       **F** - Flood<sup>(3)</sup>       **WF** - Wide flood<sup>(4)</sup>

**VOLTAGE**

**120** - 120V       **277** - 277V

**FINISH** (Trim finish / Baffle finish)

	<b>White Trim</b>	<b>Gray Trim</b>	<b>Black Trim</b>	<b>Trimless</b>
<input checked="" type="checkbox"/> <b>Black baffle</b>	<input type="checkbox"/> <b>01</b> - White/Black	<input type="checkbox"/> <b>10</b> - Gray/Black	<input type="checkbox"/> <b>02</b> - Black/Black	<input type="checkbox"/> <b>02</b> - Black
<input checked="" type="checkbox"/> <b>White baffle</b>	<input type="checkbox"/> <b>31</b> - White/White			<input type="checkbox"/> <b>31</b> - White

**DIMMING\***

**D10** - 0-10V       **LTE** - Leading and trailing edge (120V only)

<sup>(1)</sup> 3000K 80CRI (**830**) only available with trim (**TR**) and wide flood (**WF**) optic.  
<sup>(2)</sup> Medium (**M**) optic only available for 2700K 90CRI (**927**), and 3000K 90CRI (**930**) in single (**L1**) model.  
<sup>(3)</sup> Flood (**F**) optic only available with 2700K 90CRI (**927**), 3000K 90CRI (**930**) and 3500K 90CRI (**935**) in single (**L1**) model.  
<sup>(4)</sup> Double (**L2**) and triple (**L3**) only available with wide flood (**WF**).  
 \*15% dimming options: For leading and trailing edge and 0-10V (**LTE** and **D10**), the dimming levels will vary depending on the dimmer used and the number of luminaires on the line.

**INSTALLATION OPTION**

**New construction with plaster frame**

Plaster frame with hanger bars system to be installed during rough-in phase.  
Single cell model (LBL1) suitable for insulated ceiling.  
Double and triple cell models (LBL2/LBL3) suitable for non-insulated ceiling.  
Available for assemblies like sheetrock, acoustic tiles, or paneling.  
The plaster frame can be shipped separately.

**Ceiling thickness:**

Trim: 1/8" to 1 1/8" (3mm - 29mm)

Trimless: 3/8" to 1" (9mm - 25mm)

**Total weight:** Max 5.4lbs (2.45kg)

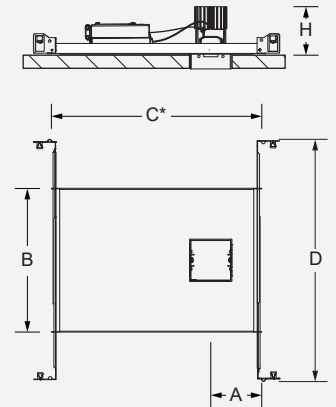

\*Provide a minimum of 1/4" (46mm) on each side for the hanger bar fixations

Model	Mounting	Plaster frame	Cut-out dimensions	Cut-out position (A)	Overall dimensions (BxC)	Hanger bars (D)	Clearance (H)
LBL1	TRIM	<b>BN5131</b>	3" x 3" (75 x 75mm)	3 1/2" (89mm)	10" x 14 5/8" (254mm x 371mm)	14 1/4" to 26" (362 to 660mm)	6" (152mm)
	TRIMLESS	<b>BN5134</b>	2 7/8" x 2 7/8" (74 x 74mm)				
LBL2	TRIM	<b>BN5132</b>	5 3/4" x 3" (145 x 75mm)	6 3/4" (171mm)	13 1/2" x 13 1/2" (343mm x 343mm)		
	TRIMLESS	<b>BN5135</b>	5 5/8" x 2 7/8" (143 x 74mm)				
LBL3	TRIM	<b>BN5133</b>	8 3/8" x 3" (214 x 75mm)	8 5/8" (206mm)	14 1/2" x 16 1/8" (368mm x 410mm)		
	TRIMLESS	<b>BN5136</b>	8 1/4" x 2 7/8" (213 x 74mm)				

**TRIM MODELS DIMENSIONS**

**LBL1**

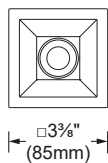

**LBL2**

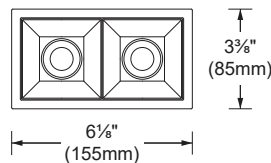

**LBL3**

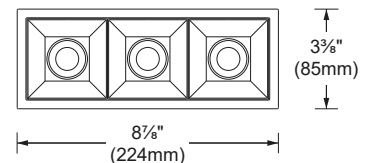

**BOTTOM VIEW**

**TRIMLESS MODELS DIMENSIONS**

**LBL1**

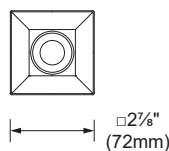

**LBL2**

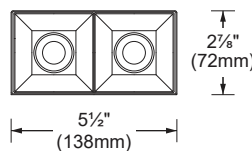

**LBL3**

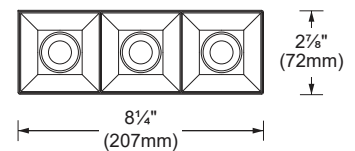

**BOTTOM VIEW**

**LED COLOR FIDELITY DATA**

CRI	CCT	R1	R2	R3	R4	R5	R6	R7	R8	R9	R10	R11	R12	R13	R14	R15	Rf	Rg	Melanopic ratio
80	4000K	82	91	96	82	83	87	86	65	11	78	82	65	85	98	-	85	95	0.694
90	2700K	94	98	99	94	95	98	91	82	61	95	96	88	96	99	-	93	99	0.497
	3000K	94	97	99	94	94	96	93	83	62	92	95	84	95	99	-	93	99	0.563
	3500K	93	96	98	93	93	95	93	84	62	90	94	78	94	98	-	92	98	0.642

**PHOTOMETRIC DATA**

Visit [iguzzini.com/us](http://iguzzini.com/us) for complete photometric data.

PHOTOMETRIC DATA MAY VARY ACCORDING TO FINISH.

**LBL1**



CCT (K)*	CRI	LOAD (W)	OPTIC	LUMENS (lm)	EFFICACY (lm/W)	MAX CANDELA (cd)	MODELS
3000K	90	10W	Medium 24°	740	74	3 045	ILBL1-TR/TL-930-M
			Flood 31°	825	82	2 565	ILBL1-TR/TL-930-F
			Wide flood 54°	855	85	1 230	ILBL1-TR/TL-930-WF

\*USE MULTIPLIER TABLE FOR OTHER CCT AND CRI OUTPUT DATA

Medium 24° (3000K, 90CRI)

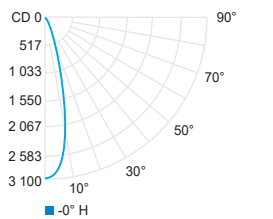

Center beam fc	Beam width ft
2ft	762 0.8
4ft	191 1.7
6ft	84.7 2.5
8ft	47.6 3.4
10ft	30.5 4.2
12ft	21.2 5.1

Flood 31° (3000K, 90CRI)

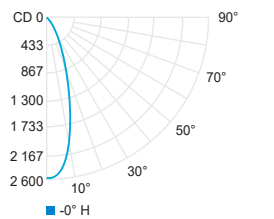

Center beam fc	Beam width ft
2ft	642 1.1
4ft	161 2.2
6ft	71.4 3.3
8ft	40.1 4.4
10ft	25.7 5.5
12ft	17.8 6.6

Wide flood 54° (3000K, 90CRI)

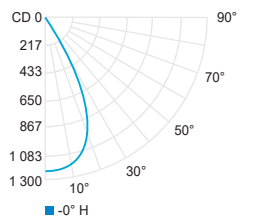

Center beam fc	Beam width ft
2ft	308 2.1
4ft	77.0 4.1
6ft	34.2 6.2
8ft	19.3 8.2
10ft	12.3 10.3
12ft	8.56 12.3

**LBL2**



PHOTOMETRIC DATA MAY VARY ACCORDING TO FINISH.

CCT (K)*	CRI	LOAD (W)	OPTIC	LUMENS (lm)	EFFICACY (lm/W)	MAX CANDELA (cd)	MODELS
3000K	90	23W	Wide flood 54°	1 800	78	2 580	ILBL2-TR/TL-930-WF

\*USE MULTIPLIER TABLE FOR OTHER CCT AND CRI OUTPUT DATA

Wide flood 54° (3000K, 90CRI)

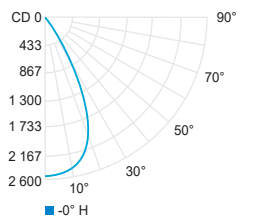

Center beam fc	Beam width ft
2ft	645 2.1
4ft	161 4.1
6ft	71.7 6.2
8ft	40.3 8.2
10ft	25.8 10.3
12ft	17.9 12.3

**PHOTOMETRIC DATA**

Visit [iguzzini.com/us](http://iguzzini.com/us) for complete photometric data.

PHOTOMETRIC DATA MAY VARY ACCORDING TO FINISH.

**LBL3**



CCT (K)*	CRI	LOAD (W)	OPTIC	LUMENS (lm)	EFFICACY (lm/W)	MAX CANDELA (cd)	MODELS
3000K	90	33.5W	Wide flood 54°	2 700	80	3 870	ILBL3-TR/TL-930-WF

**\*USE MULTIPLIER TABLE FOR OTHER CCT AND CRI OUTPUT DATA**

Wide flood 54° (3000K, 90CRI)

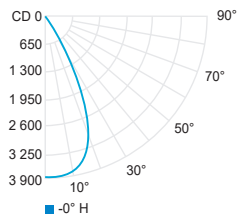

	Center beam fc	Beam width ft
2ft	968	2.1
4ft	242	4.1
6ft	108	6.2
8ft	60.5	8.2
10ft	38.7	10.3
12ft	26.9	12.3

CCT options	2700K	3000K	3500K	4000K
CRI options	90CRI	90CRI	90CRI	80CRI
<b>Multiplier</b>	<b>0.95</b>	<b>1</b>	<b>1</b>	<b>1.19</b>