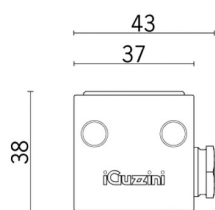

Dernière mise à jour des informations: Octobre 2024

Configuration du produit: BQ64

BQ64: Mini - Wall-/Ceiling-mounted - Warm White LED - 24V/500mA dc - L=528mm - 10° Spot Optic

**Référence produit**

BQ64: Mini - Wall-/Ceiling-mounted - Warm White LED - 24V/500mA dc - L=528mm - 10° Spot Optic

Description technique

Direct light luminaire, designed to use monochrome LED lamps. Ceiling- and wall-mounted. Consists of a body and supports for installation (to be ordered separately). Extruded aluminium body, with zamak die-cast end caps complete with silicone gaskets. Coated with liquid acrylic paint with a high level of weather and UV ray resistance. The top of the optical assembly is closed by a 3 mm thick transparent glass screen, fixed with silicone. Complete with multi-LED power plate in Warm White with 24V/500mA dc electronic circuit (power supply to be ordered separately); 24V/500mA smart driver allowing constant light flow emission despite variations in the input voltage (from 30V dc to 16V dc). Fitted with satin-finish polycarbonate film and optics with plastic (methacrylate) lens for 10° SPOT lighting. All external screws used are made of A2 stainless steel. The luminaire technical characteristics conform to EN 60598-1 standards and particular requirements.

Installation

The following accessories are available for installation: adjustable wall-mounted arms in AISI304 stainless steel (L=83mm code BZJ9, 200mm code BZJ8) and a plate for surface- or ceiling-mounting made of anodised aluminium (BZJ6).

Coloris

Gris (15)

Poids (Kg)

0.89

Montage

applique murale/en saillie au plafond

Câblage

The product is supplied with a single nickel-plated brass cable gland PG9 and a 2x1mm² PVC and polyurethane outlet cable, 2000mm long. For the electrical connection there is an IP68 linear connector (BZK6) and an IP67 junction box with quick-coupling terminals (BZK7). 24V/500mA dc electronic ballasts to be ordered separately: 32W (BZA0), 25W (K980) and 35W (BZM4)

Remarque

Product complete with LED lamp

Conforme à la norme EN60598-1 et à la réglementation en vigueur (ou à la réglementation relative)

**Données techniques**

Im du système:	433	Température de couleur [K]:	2700
W du système:	9.3	MacAdam Step:	3
Im source:	610	Durée de vie LED 1:	66,000h - L80 - B10 (Ta 25°C)
W source:	9.3	Durée de vie LED 2:	66,000h - L80 - B10 (Ta 40°C)
Efficacité lumineuse (lm/W, valeurs du système):	46.6	Code Lampe:	LED
Im en mode secours:	-	Nombre de lampes par groupe optique:	1
Flux total émis à un angle de 90° ou plus [Lm]:	0	Code ZVEI:	LED
Light Output Ratio (L.O.R.) [%]:	71	Nombre de groupes optiques:	1
Angle d'ouverture [°]:	10°	Plage de température ambiante opérative:	De -30°C à 50°C.
IRC (minimum):	80	LED Courant [mA]:	500

Polaire

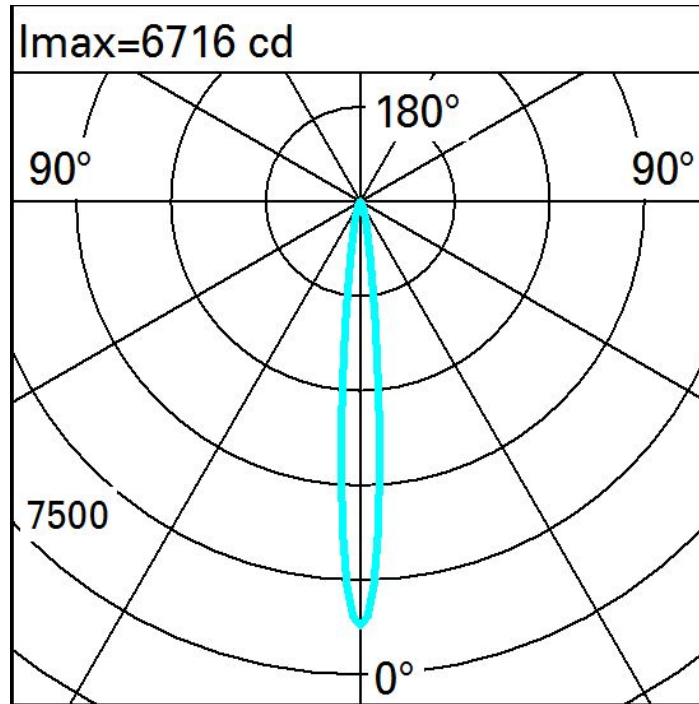

Eclairéments

