

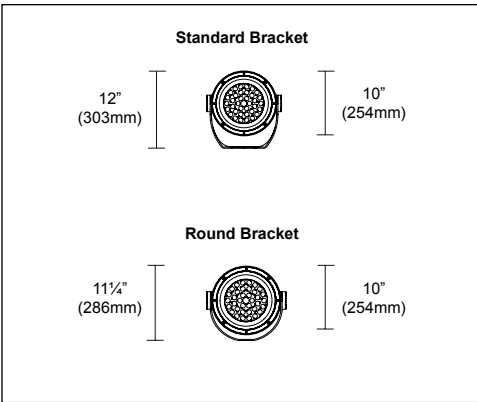

High-performance outdoor architectural floodlight enhancing urban spaces and bringing life to cities.

FEATURES

- Delivers 3,225 – 5,737 lumens at 3000K, 80CRI
- Up to 95 lm/W at 3000K, 80CRI
- Vertical or horizontal surface and pole specification [page 2-3](#)
- 0-10V or DMX-RDM dimming down to 10%
- Additional sizing available: Ø8", Ø12.5", Ø14.5", or Ø20.5" [↗](#)
- RGBW available with Ø12.5", Ø14.5", or Ø20.5"
- Max candela of 3,814 – 300,819
- Consult factory for further customization
- Full specification available [page 6](#)



FINISH OPTIONS

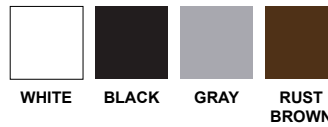

Consult factory for custom finishes

OPTIC OPTIONS

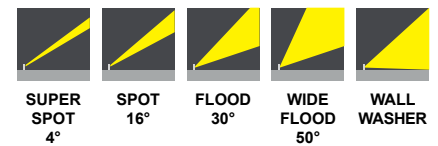

ORDERING INFO

PRODUCT CODE

EXAMPLE: IAGR-NM-BO-827-SP-REM-02

MODEL	SIZE	OUTPUT	LED	OPTIC	VOLTAGE	FINISH
IAGR With standard bracket	NM Mini Ø10" (254mm)	BO Base Output (49.8–53.6W)	822 ¹ 2200K, 80CRI	SS Super Spot, 4°	REM Remote	01 White
IAGRS With round bracket		HO High Output (60.9–61.9W)	827 2700K, 80CRI	SP Spot, 16°		02 Black
			830 3000K, 80CRI	FL Flood, 30°		15 Gray
			835 ² 3500K, 80CRI	WF Wide Flood, 50°		F5 Rust Brown
			840 4000K, 80CRI	WW Wall Washer		
			935 ³ 3500K, 90CRI			

1. Available for super spot (SS), flood (FL) and wall washer (WW) optics.
2. Not available for super spot (SS) optics.
3. Only available for super spot (SS) optics.

ACCESSORIES

To be ordered separately.
 More information on all accessories on [page 3](#).

CONNECTION ACCESSORY CODE

EXAMPLE: IX765+IX768

CONNECTION ACCESSORIES	
IP68 CONNECTION KIT	RESISTOR DMX KIT
<input type="checkbox"/> IX765 3 way male/female junction for serie connection, 600V	<input type="checkbox"/> RES-058-KIT End of line 120 ohms thermal resistance kit
<input type="checkbox"/> IX768 3 poles male + female connector, 600V	
<input type="checkbox"/> 4543-00 Connection box	

OPTIC ACCESSORY CODE

EXAMPLE: IX722+IX726

OPTIC ACCESSORIES	
EXTERNAL (1 MAX)	INTERNAL (1 MAX)
<input type="checkbox"/> IX722 Protection Grid (for IK10)	<input type="checkbox"/> IX726 Elliptical Distribution Refractor
<input type="checkbox"/> IX723 Cylindrical Screen	<input type="checkbox"/> IX727 Diffusing Glass
<input type="checkbox"/> IX724 Cylindrical Screen 30°/45°	<input type="checkbox"/> IX725 Longitudinal Louver

DRIVER CODE

EXAMPLE: 4449-0700-075-UNV-D10

DRIVER

Driver options are available on [page 4](#).

POLE SPECIFICATION

To be ordered separately.

POLE SPECIFICATION

iGuzzini Pole

Diameter Ø4" (Ø 102mm)
Shape Round
Model Straight
Installation Anchor bolts
Access Door Included (3' from ground)

Height

ft

Finish

01 - White RAL9016

02 - Black RAL9005

15 - Gray RAL9007

Material

Aluminum

F5 - Rust Brown RAL8017

Galvanized Steel

 RAL# Enter custom RAL

Supplied by other

Pole provided by another manufacturer

POLE-MOUNTED ACCESSORIES

To be ordered separately.

For available configuration and details on installation, consult the instruction sheet.
 Pole Ø: 4" (102mm). Consult instruction sheet for more layouts.



Agorà (NM) + Cylindrical Screen EPA 0.79ft² (0,074m²)

To have the total EPA, add all the EPA values for each items in the composition.

FINISH

01
White

02
Black

15
Gray

F5
Rust Brown

POLE INSTALLATION WITH ARMS

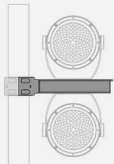

IX568
Arm for 1/2 floodlights

Length 19¼" (488mm)
Weight 11.11lb (5.04kg)
EPA 0,33ft² (0,031m²)

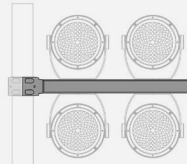

IX570
Arm for 2/4 floodlights

Length 37¼" (946mm)
Weight 18.14lb (8.23kg)
EPA 0,64ft² (0,060m²)

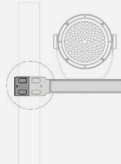

I6161
Counter Flange

Weight 4.76lb (2.16kg)
EPA 0,064ft² (0,006m²)

MANDATORY ADAPTOR WITH ARM IX568 / IX570



IX657
For up side application



IX572
For down side application

POLE INSTALLATION WITH FLANGES

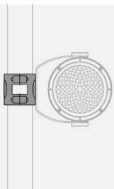

I6111
Flange for 1 floodlight

Weight 1.98lb (0.9kg)
EPA 0,13ft² (0,013m²)

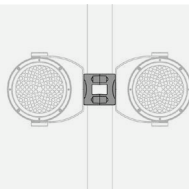

I6112
Flange for 2 floodlights

Weight 2.20lb (1kg)
EPA 0,13ft² (0,013m²)

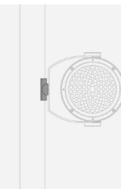

IX738
Minimal flange

Pole must have threaded hole to hold minimal flange IX738.
 See instruction sheet for threading information.

MULTI SUPPORT

To be ordered separately.
For available configuration and details on installation, consult the instruction sheet.
Need a IX562 connector for every pole mounted fixture.

FINISH

01
White

02
Black

15
Gray

F5
Rust Brown

MULTI SUPPORT

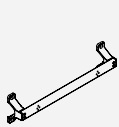

I6014
For 2 floodlights

Dimensions
37 ¼ x 9 ¼ x 5 ½"
(962 x 236 x 141mm)

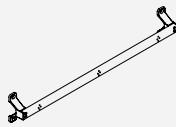

I6015
For 3 floodlights

Dimensions
61 ¼ x 9 ¼ x 5 ½"
(1560 x 236 x 141mm)

CONNECTION ACCESSORIES

To be ordered separately.
For available configurations and details on installation, consult the instruction sheet.

IP68 CONNECTION KIT

For available configurations and details on installation, consult the instruction sheet.
No finish option available.

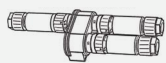

IX765
3 way male/female
junction connector for serie
connection, 600V.

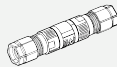

IX768
3 poles male + female
connector, 600V.



4543-00
Connection box

RESISTOR DMX KIT

For DMX driver box. One pc needed at the end of the line.



RES-058-KIT
End of line 120 ohms thermal resistance kit.

OPTIC ACCESSORIES

To be ordered separately.
For installation, consult instruction sheet.

EXTERNAL (1 MAX)



IX722
Protection Grid (for IK10)
(Stainless Steel)

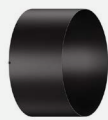

IX723
Cylindrical Screen
(Black)



IX724
Cylindrical Screen 30°/45°
(Black)

INTERNAL (1 MAX)



IX726¹
Refractor for elliptical
distribution



IX727¹
Diffusing Glass



IX725¹
Longitudinal Louver
(Black)

¹ Not available for wall washer version.

REMOTE LED DRIVER OPTIONS

DRIVER CODE

EXAMPLE: 4449-0700-075-UNV-D10

INDOOR RATED Driver Box Models	Min-max units			
	For All Models		For SS Optics Only	
	BO (45W)	HO (53W)	BO(43W)	(55W)
<input type="checkbox"/> 4449-0840-075-UNV-D10			1	
<input type="checkbox"/> 4449-0840-075-UNV-DMX			1	
<input type="checkbox"/> 4449-0840-120-UNV-D10			2	
<input type="checkbox"/> 4449-0840-120-UNV-DMX			2	
<input type="checkbox"/> 4449-0840-192-UNV-D10			2-3	
<input type="checkbox"/> 4449-0840-192-UNV-DMX			2-3	
<input type="checkbox"/> 4449-0840-320-UNV-D10			4-6	
<input type="checkbox"/> 4449-0840-320-UNV-DMX			4-6	
<input type="checkbox"/> 4446-0840-456-UNV-D10			5-9	
<input type="checkbox"/> 4446-0840-456-UNV-DMX			5-9	
<hr/>				
<input type="checkbox"/> 4449-0700-075-UNV-D10	1			
<input type="checkbox"/> 4449-0700-075-UNV-DMX	1			
<input type="checkbox"/> 4449-0700-160-UNV-D10	2			
<input type="checkbox"/> 4449-0700-160-UNV-DMX	2			
<input type="checkbox"/> 4449-0700-320-UNV-D10	3-5			
<input type="checkbox"/> 4449-0700-320-UNV-DMX	3-5			
<input type="checkbox"/> 4449-0700-380-UNV-D10	5-7			
<input type="checkbox"/> 4449-0700-380-UNV-DMX	5-7			
<hr/>				
<input type="checkbox"/> 4449-1050-075-UNV-D10				1
<input type="checkbox"/> 4449-1050-075-UNV-DMX				1
<input type="checkbox"/> 4449-1050-150-UNV-D10				2
<input type="checkbox"/> 4449-1050-150-UNV-DMX				2
<input type="checkbox"/> 4449-1050-240-UNV-D10				2-3
<input type="checkbox"/> 4449-1050-240-UNV-DMX				2-3
<input type="checkbox"/> 4449-1050-320-UNV-D10				4-5
<input type="checkbox"/> 4449-1050-320-UNV-DMX				4-5
<input type="checkbox"/> 4449-1050-571-UNV-D10				5-9
<input type="checkbox"/> 4449-1050-571-UNV-DMX				5-9
<hr/>				
<input type="checkbox"/> 4449-1140-075-UNV-D10		1		
<input type="checkbox"/> 4449-1140-075-UNV-DMX		1		
<input type="checkbox"/> 4446-1140-150-UNV-D10		2		
<input type="checkbox"/> 4446-1140-150-UNV-DMX		2		
<input type="checkbox"/> 4446-1140-240-UNV-D10		2-3		
<input type="checkbox"/> 4446-1140-240-UNV-DMX		2-3		
<input type="checkbox"/> 4446-1140-620-UNV-D10		5-9		
<input type="checkbox"/> 4446-1140-620-UNV-DMX		5-9		

OUTDOOR RATED Driver Box Models	Min-max units			
	For All Models		For SS Optics Only	
	BO (45W)	HO (53W)	BO(43W)	(55W)
<input type="checkbox"/> 4549-0840-075-UNV-D10			1	
<input type="checkbox"/> 4549-0840-075-UNV-DMX			1	
<input type="checkbox"/> 4549-0840-120-UNV-D10			2	
<input type="checkbox"/> 4549-0840-120-UNV-DMX			2	
<input type="checkbox"/> 4555-0840-192-UNV-D10			2-3	
<input type="checkbox"/> 4555-0840-192-UNV-DMX			2-3	
<input type="checkbox"/> 4555-0840-320-UNV-D10			4-6	
<input type="checkbox"/> 4555-0840-320-UNV-DMX			4-6	
<input type="checkbox"/> 4557-0840-456-UNV-D10			5-9	
<input type="checkbox"/> 4557-0840-456-UNV-DMX			5-9	
<hr/>				
<input type="checkbox"/> 4549-0700-075-UNV-D10	1			
<input type="checkbox"/> 4549-0700-075-UNV-DMX	1			
<input type="checkbox"/> 4549-0700-160-UNV-D10	2			
<input type="checkbox"/> 4549-0700-160-UNV-DMX	2			
<input type="checkbox"/> 4555-0700-320-UNV-D10	3-5			
<input type="checkbox"/> 4555-0700-320-UNV-DMX	3-5			
<input type="checkbox"/> 4555-0700-380-UNV-D10	5-7			
<input type="checkbox"/> 4555-0700-380-UNV-DMX	5-7			
<hr/>				
<input type="checkbox"/> 4549-1050-075-UNV-D10				
<input type="checkbox"/> 4549-1050-075-UNV-DMX				
<hr/>				
<input type="checkbox"/> 4549-1050-150-UNV-D10				2
<input type="checkbox"/> 4549-1050-150-UNV-DMX				2
<input type="checkbox"/> 4555-1050-240-UNV-D10				2-3
<input type="checkbox"/> 4555-1050-240-UNV-DMX				2-3
<input type="checkbox"/> 4555-1050-320-UNV-D10				4-5
<input type="checkbox"/> 4555-1050-320-UNV-DMX				4-5
<input type="checkbox"/> 4557-1050-571-UNV-D10				5-9
<input type="checkbox"/> 4557-1050-571-UNV-DMX				5-9
<hr/>				
<input type="checkbox"/> 4549-1140-075-UNV-D10		1		
<input type="checkbox"/> 4549-1140-075-UNV-DMX		1		
<input type="checkbox"/> 4549-1140-150-UNV-D10		2		
<input type="checkbox"/> 4549-1140-150-UNV-DMX		2		
<input type="checkbox"/> 4555-1140-240-UNV-D10		2-3		
<input type="checkbox"/> 4555-1140-240-UNV-DMX		2-3		
<input type="checkbox"/> 4557-1140-620-UNV-D10		5-9		
<input type="checkbox"/> 4557-1140-620-UNV-DMX		5-9		

DRIVER BOX MODEL DESCRIPTION

MODEL (L × W × H)	CONSTANT CURRENT	WATTAGE	VOLTAGE	DIMMING PROTOCOL
4446 16" × 12" × 4" (406 × 305 × 102mm)	0700 to 1140 700mA to 1140mA	075 to 620 75W to 620W	UNV 120-277V	D10 0-10V Max distance: 100m (330ft)* (down to 10%)
4449 12" × 8" × 4" (305 × 203 × 102mm)				DMX DMX-RDM Max distance: 100m (330ft)* (down to 1%)
4549 14.5" × 5" × 3.5" (368 × 127 × 89mm)				
4555 13" × 9" × 4.5" (330 × 229 × 114mm)				
4557 15.75" × 9" × 7.1" (400 × 229 × 180mm)				

*Max distance cable calculated for 16AWG cable. Contact customer service for longer remote distance.

WIRING DIAGRAMS

Multiple luminaires must be connected in series (home run or fixture chain)

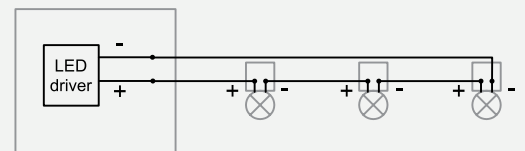

DRIVER DIMENSIONS

MODEL (L × W × H)

4446

16" × 12" × 4"
(406 × 305 × 102mm)

4449

12" × 8" × 4"
(305 × 203 × 102mm)

4549

14.5" × 5" × 3.5"
(368 × 127 × 89mm)

4555

13" × 9" × 4.5"
(330 × 229 × 114mm)

4557

15.75" × 9" × 7.1"
(400 × 229 × 180mm)

INDOOR RATED

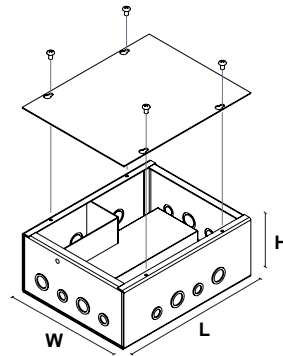

OUTDOOR RATED

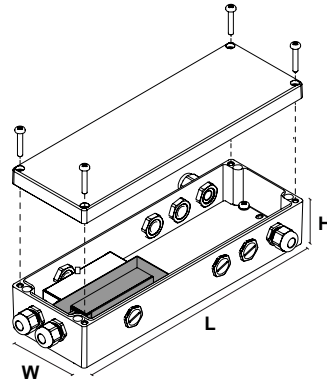

SPECIFICATIONS

Luminaire characteristic:	Power input system: 49.8W to 61.9W Lumens system for 3000K, 80CRI: 3,225lm to 5,737lm Luminaire efficacy for 3000K, 80CRI: Up to 95lm/W
Source:	White LED (LM-80), 2200K: 80CRI, 2700K: 80CRI, 3000K: 80CRI, 3500K: 80CRI, (90CRI, SS optic only) 4000K: 80CRI.
Lumen maintenance:	90% of initial lumens at 100 000 hours (L90 B10) T77 °F (25°C) 90% of initial lumens at 100 000 hours (L90 B10) T104 °F (40°C)
Optic:	Available in super spot, spot, flood, wide flood and wall washer optics. Full line of professional accessories (page 3)
Material:	Optical body, accessory holder ring: Die-cast aluminum; Optic diffuser: PMMA; Protective screen: 3/16" (4mm) thick extra-clear sodium-calcium closure glass. Mounting bracket: Steel.
Mounting:	Vertical or horizontal surface (page 3) and pole mount (page 2) with included mounting bracket. Supplied with 23ft (7m) of power cable. SOOW 3/18AWG power cable.
Adjustment:	Bracket can be rotated up to 70° on the horizontal plane (see instruction sheet for details on adjustment). Optical body can be tilted up to 180° or 220°.
Electrical:	High efficiency dimmable remote LED driver, rated at 50,000 hours. 120V/277V. See remote options (page 4)
Dimming:	0-10V or DMX-RDM (120-277V), down to 10%. See dimmable remote options (page 4).
Finish:	Black (RAL9005), gray (RAL9007), rust brown (RAL8017) or white (RAL9016), painted finish with a high level of weather and UV resistance. The coating is electrostatically applied, durable acrylic enamel baked at high temperatures for superior color retentive finish.
Operating temperature:	BO: -30°C to 50°C (-22°F to 122°F); HO: -30°C to 35°C (-22°F to 95°F);
Weight:	NM - mini Ø10" 7.94lb (3.6kg)
Warranty:	5 year limited warranty.
Ratings:	IP66, IK08
Certification:	cULus listed for wet location.



DIMENSIONS

Bracket is included. For adjustment details, consult instruction sheet.

WITH STANDARD BRACKET

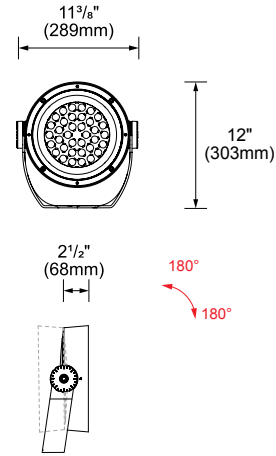

WITH SHORT BRACKET

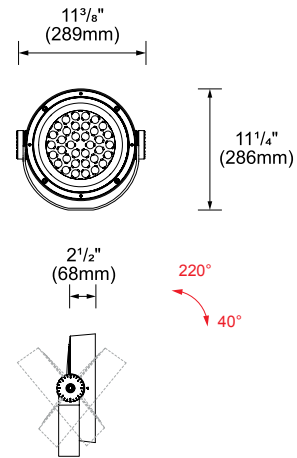

PROFESSIONAL OPTICS

12 Total Optics Combinations with Elliptical Distribution Refractor and Diffuser Glass accessories

Primary Optics

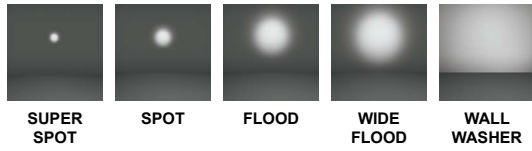

With Elliptical Distribution Refractor

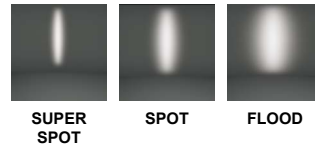

With Diffuser Glass

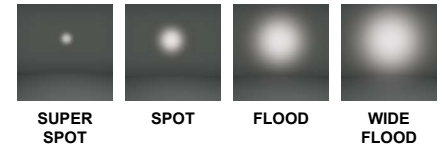

PROFESSIONAL ACCESSORIES

INTERNAL ACCESSORIES (Choose only one)

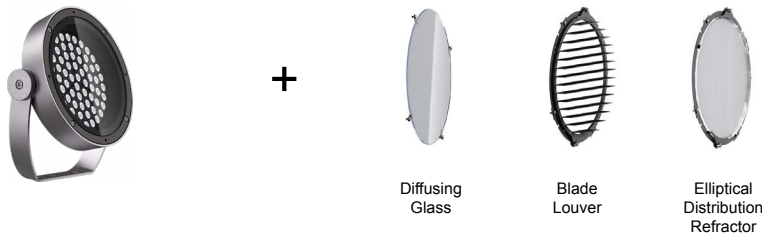

EXTERNAL ACCESSORIES (Choose only one)

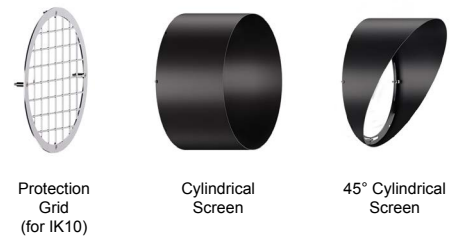

OPTI BEAM LENS + REFRACTORS

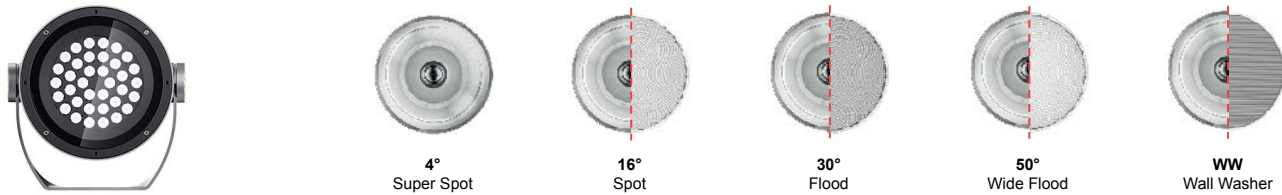

FAMILY OVERVIEW



PHOTOMETRIC DATA

CCT (K)	CRI	OUTPUT	LOAD* (W)	OPTIC	LUMENS (lm)	EFFICACY (lm/W)	MAX CANDELA (cd)	MODELS
3000	80	BO	49.8	Super spot 4°	3,225	64	258,704	IAGR-NM-BO-830-SS
			53.6	Spot 16°	5,121	95	41,515	IAGR-NM-BO-830-SP
				Flood 30°	5,054	94	16,192	IAGR-NM-BO-830-FL
				Wide flood 50°	4,921	91	6,275	IAGR-NM-BO-830-WF
				Wall washer	4,123	76	3,814	IAGR-NM-BO-830-WW
		HO	61.9	Super spot 4°	3,750	60	300,819	IAGR-NM-HO-830-SS
			60.9	Spot 16°	5,737	94	46,509	IAGR-NM-HO-830-SP
				Flood 30°	5,662	92	18,140	IAGR-NM-HO-830-FL
				Wide flood 50°	5,513	90	7,030	IAGR-NM-HO-830-WF
				Wall washer	4,619	75	4,273	IAGR-NM-HO-830-WW

*Power can vary with selected drivers. Use multiplier table for other CCT and CRI output data. Efficacy based on IESNA LM-79 test reports. Visit iguzzini.com/us for complete photometric data.

BO Super Spot, 4° (3000K, 80CRI)

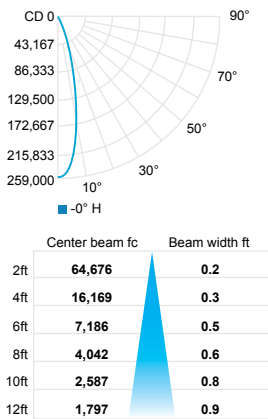

BO Spot, 16° (3000K, 80CRI)

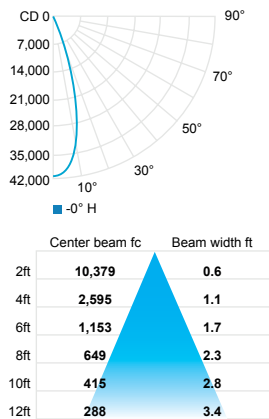

BO Flood, 30° (3000K, 80CRI)

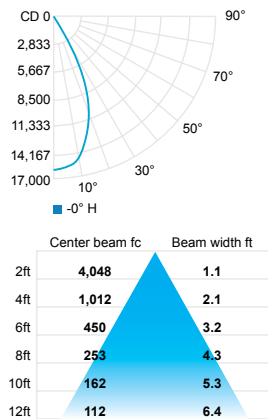

BO Wide Flood, 50° (3000K, 80CRI)

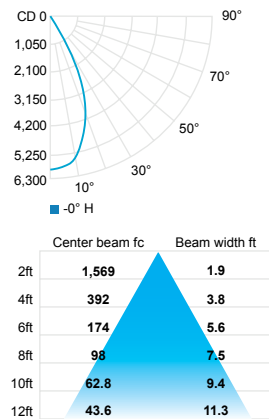

BO Wall Washer (3000K, 80CRI)

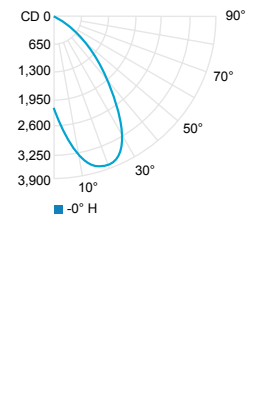

HO Super Spot, 4° (3000K, 80CRI)

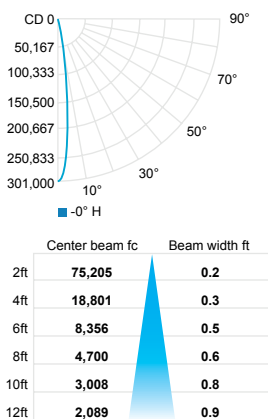

HO Spot, 16° (3000K, 80CRI)

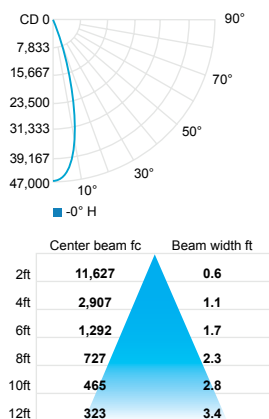

HO Flood, 30° (3000K, 80CRI)

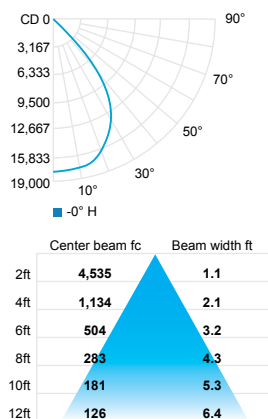

HO Wide Flood, 50° (3000K, 80CRI)

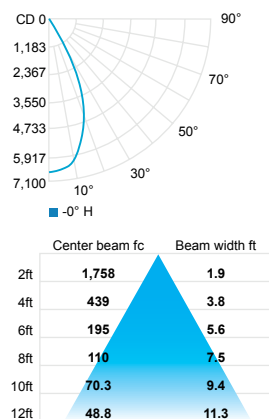

HO Wall Washer (3000K, 80CRI)

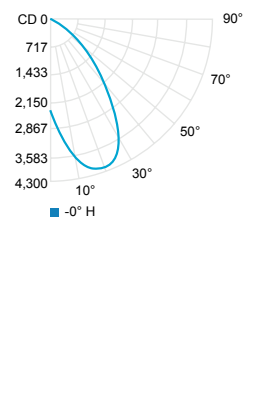

CCT options	2200K	2700K	3000K	3500K	3500K	4000K
CRI options	80CRI	80CRI	80CRI	80CRI	90CRI	80CRI
Multiplier	0.85	0.96	1	1	-	1.05
Multiplier for Super spot	0.75	0.95	1	-	0.75	1.09